

1.4

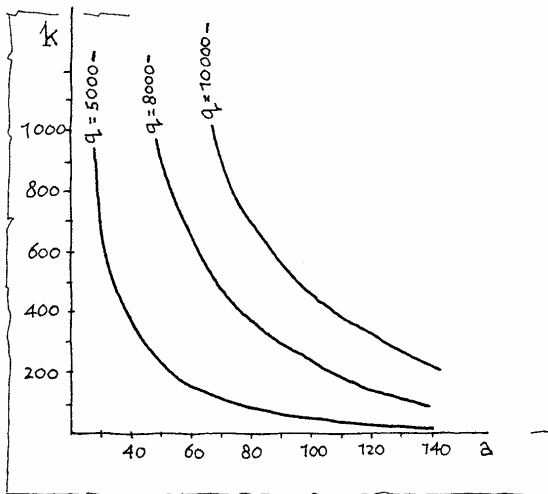

4.1

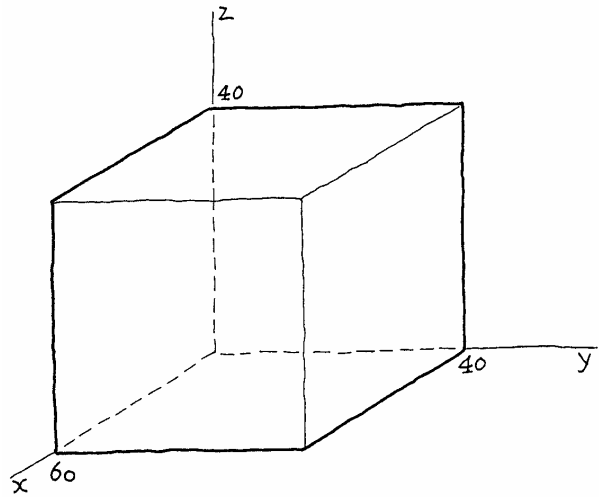

4.2

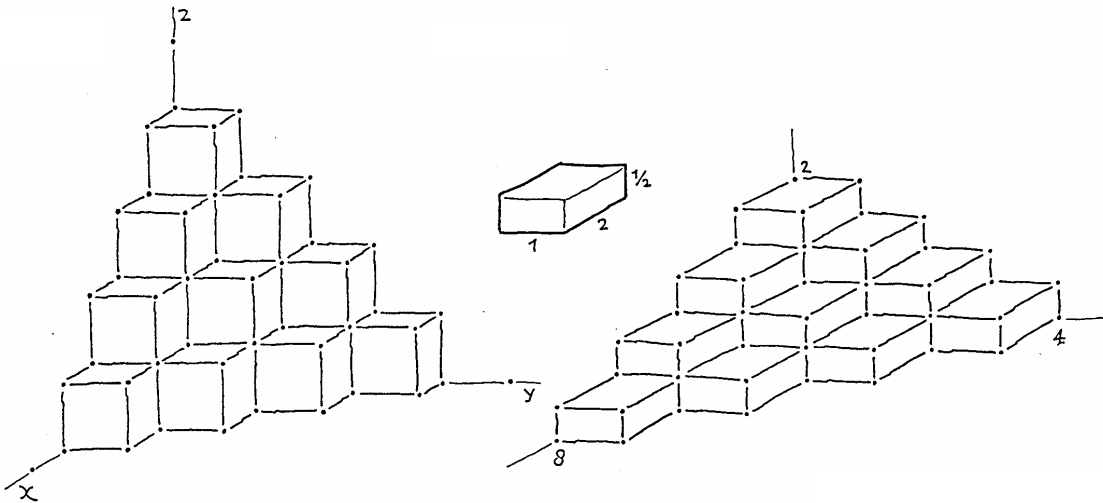

4.3

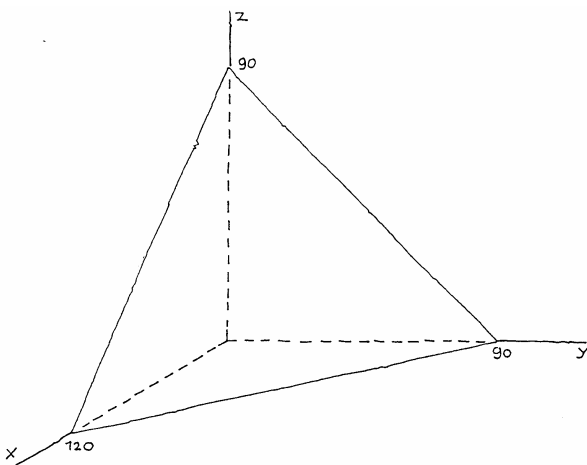

4.5

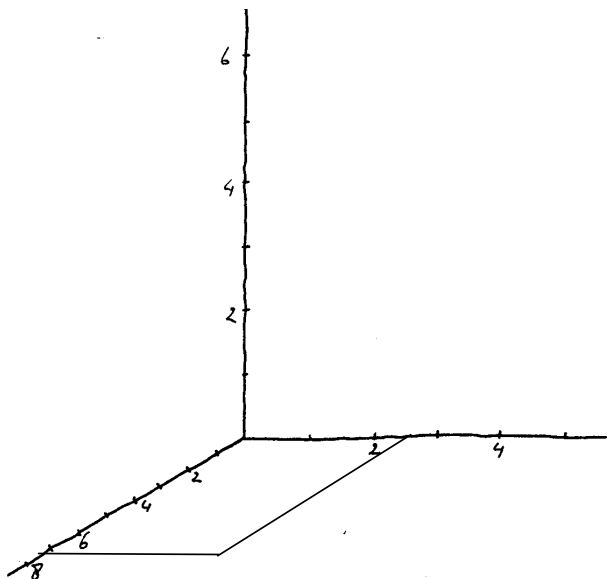

4.7

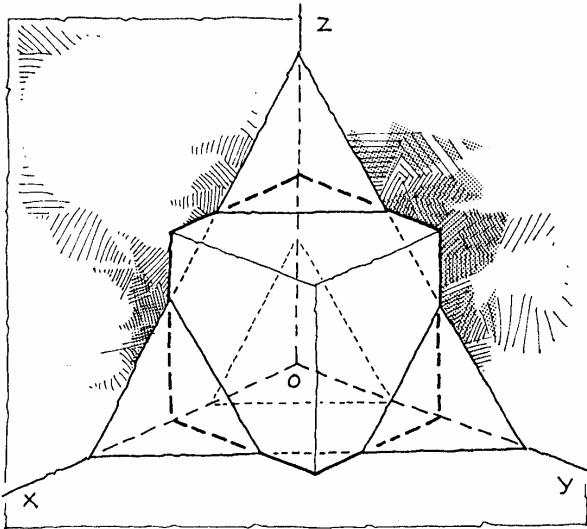

4.8

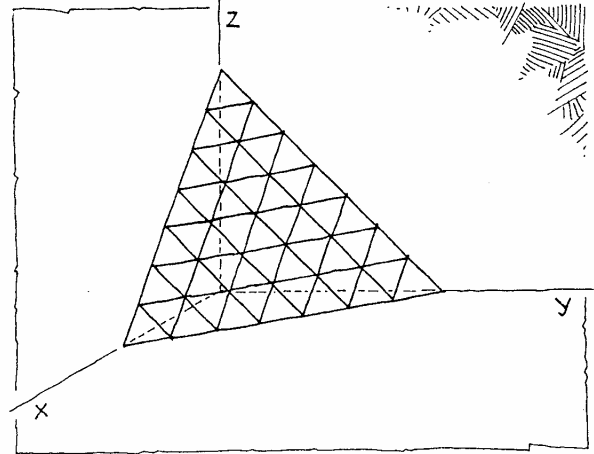

5.2

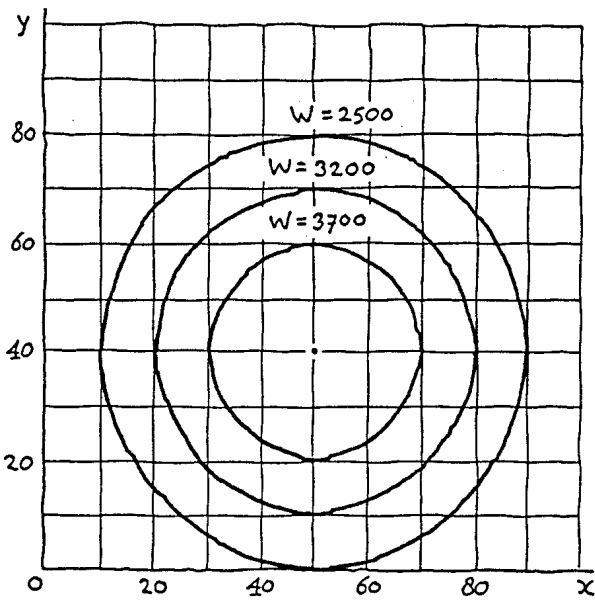

5.3

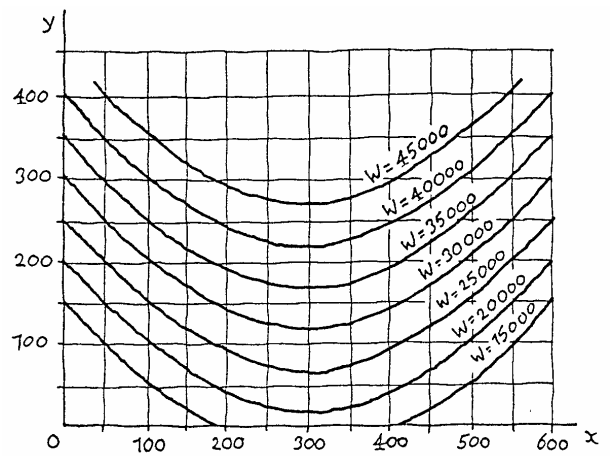

bouwplaat bij opgave 4.5

